

Characterization of the Dynamic Behaviour of a Basketball Goal Mounted on a Ceiling

Matija Javorski – Primož Čermelj – Miha Boltežar*
University of Ljubljana, Faculty of Mechanical Engineering, Slovenia

An experimental modal analysis was performed on an existing basketball goal, with the modes, natural frequencies and damping ratios identified. On this basis, a numerical model was created, employing the finite-element method. Due to the correlation between the experimental and the numerical results, the model was accepted as valid. Subsequently, this model was used to analyse the transient response that occurs when a fully loaded goal suddenly becomes unloaded. The resulting oscillation was compared to the valid standard for this type of sports equipment.

©2010 Journal of Mechanical Engineering. All rights reserved.

Keywords: basketball, steel structures, finite element method, experimental modal analysis, oscillations

0 INTRODUCTION

The trend of building ever-larger sports halls is a world-wide phenomenon. Inevitably, ceiling heights are also increasing and, supposing that a ceiling basketball goal is used, it must span greater vertical distances. The suitability and quality of a goal, mounted on a ceiling at a height of 13, 14 or 15 m cannot be evaluated merely on the basis of data acquired from a stress analysis, as the flexibility of the goal is not negligible. In the event of a score with a dunk shot, the dynamic properties of the structure come into play and these can significantly influence the subsequent quality of the game. This fact has also been considered by the FIBA organization, which defined the maximum time for which any vibration could remain visible to be 4 seconds [1].

The objective of this research was, firstly, to create a valid numerical model that makes it possible to conduct a valid analysis of the dynamic behaviour of the structure under investigation. For this purpose, an experimental modal analysis (EMA) was conducted on the actual structure, Fig. 1, and the results were then used to create a valid finite-element model. Secondly, once a valid numerical model was obtained, it was used in a transient numerical analysis. The aim was to investigate whether the structure satisfies the prescribed standards. In case the demands would not have been met or additional requirements emerged, the model could also be used as an evaluation tool in a modification process.

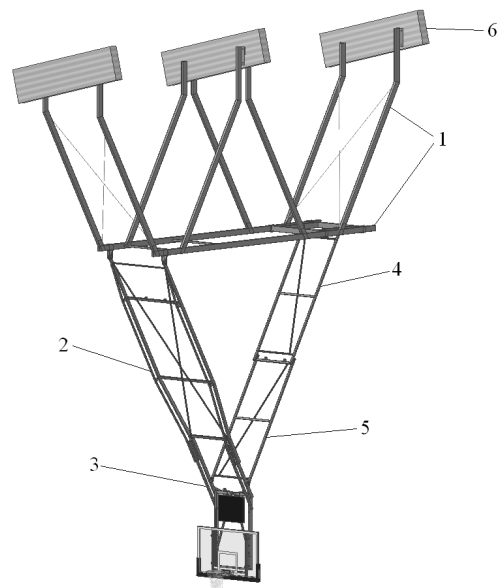

Fig. 1. Ceiling basketball goal assembly; 1) base, 2) upper main arm, 3) lower main arm, 4) upper foldable arm, 5) lower foldable arm, 6) ceiling

Since the basketball goal assembly is relatively involved, with welds as well as bolted and pinned joints, and even a nonlinear connection between the foldable arms, building a suitably simple but still valid model is one of the most important steps in such approaches. There has been a great deal of research conducted in the field of joints and their use in structural dynamics, e.g., [2] and [3]. But, for our purpose, the most important are the guidelines on how to incorporate complex joints into the linear

*Corr. Author's Address: University of Ljubljana, Faculty of Mechanical Engineering, Aškerčeva 6, 1000 Ljubljana, Slovenia, miha.boltezar@fs.uni-lj.si

structural dynamics. Such works, mostly emphasizing the validity of the model and valid but simplified models of complex sub-structures, can be found in [4] to [8]. Moreover, as was already established by Ewins and Inman [9] and Dascotte and Swindell [10]: "The model should be as simple as possible, while still reflecting the most significant properties". Our approach was also constrained by the methods of linear structural dynamics and thus focused on the overall validity of the model.

1 MODAL ANALYSIS

1.1 Experimental Modal Analysis

In order to acquire the modes, frequencies and damping ratios, the EMA was carried out on the selected basketball goal using the MISO (multiple input, single output) approach with a fixed accelerometer and a roving hammer as the excitation. The measurement setup is displayed schematically in Fig. 2.

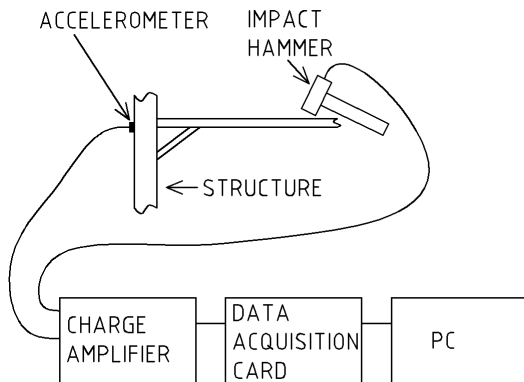

Fig. 2. Measurement setup

For the actual modal testing, 14 measurement points (1 to 14) were selected, mostly on the lower part of the goal, Fig. 3. This was due to the fact that this part of the structure is excited the most. The accelerometer was positioned at point 8 on the lower main arm and oriented in a lateral direction (with respect to the court), while at the other 13 points, the structure was excited in two or three mutually perpendicular directions, depending on the accessibility of the measurement point. Overall, 36 frequency-response functions (FRFs) were

recorded (Fig. 4) and the modal identification was conducted using custom-made EMA software. More specifically, a generalized least-squares fitting of the MIMO (multiple input, multiple output), frequency-domain algorithm [11] was used to extract the modal parameters

$$H_{N_o \times N_i}(\omega) = \sum_{r=1}^N \frac{\phi_r \phi_r^T}{i\omega - \lambda_r} + \frac{\phi_r^* \phi_r^{*T}}{i\omega - \lambda_r^*} = \sum_{r=1}^N \frac{A_r A_r^T}{i\omega - \lambda_r} + \frac{A_r^* A_r^{*T}}{i\omega - \lambda_r^*}, \quad (1)$$

with the N_o output and the N_i input coordinates, and with ϕ_r being the complex modal vectors and λ_r being the complex modal frequencies. $H_{N_o \times N_i}$ is a matrix of measured FRFs for the structure.

In our case there were 36 input coordinates and one output coordinate. Points 130 and 140 were introduced artificially for the purpose of better visualisation, Fig. 3.

Despite the fact that the structure has many modes in the frequency band from 0 to 100 Hz, we were mostly focused on the frequency band ranging from 0 to 10 Hz. Even with this the modal density was relatively high and a suitable correlation between the experimental and numerical model as well as a good insight into the dynamics of the structure was essential for the subsequent analysis.

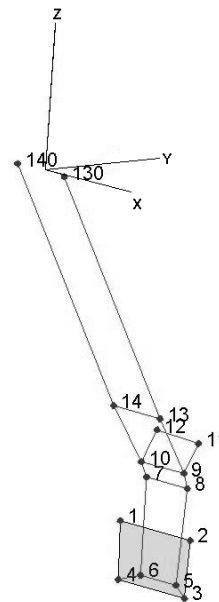

Fig. 3. Measurement points on the basketball goal

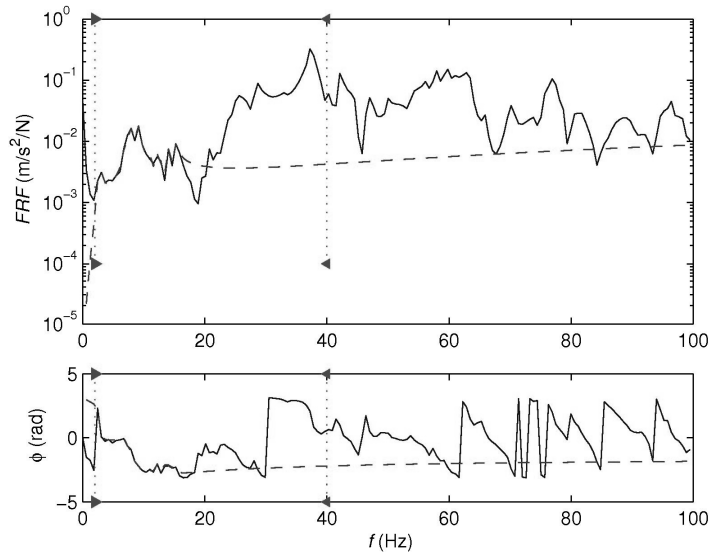

Fig. 4. One of the measured FRFs (solid line) and its reconstruction (dashed line) showing the quality of the EMA

1.2 Numerical Modal Analysis

A numerical modal analysis for the basketball goal was carried out using a FEA (finite-element analysis) approach. Since the great majority of the structure is made from long and relatively slender rectangular steel tubes, it was acceptable to model the goal as a system of beams. By default, all the members but the pinned joints, enabling the folding of the goal (Fig. 5), were rigidly coupled at their junctures.

The pinned joints were modelled as a special type of node coupling, with all the relative translations being fixed, while only the rotation around the axis of the joint was released. However, the most complex connection on the structure is at the location where the adjustable bolt from the upper foldable arm contacts the surface of the lower foldable arm, Fig. 6.

It is evident that only the compressive forces can be transferred across this connection, while the design of the goal is such that its own weight provides these forces, keeping the goal in the operational position. In performed model, the bolt was simplified by creating a binding with a similar geometry to the bolt, rigidly coupled to both folding arms. This was a necessary but reasonable simplification that does not affect the global response of the structure, as will be evident from the results.

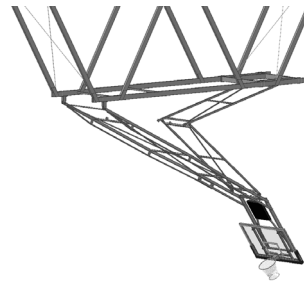

Fig. 5. Folding action of the basketball goal

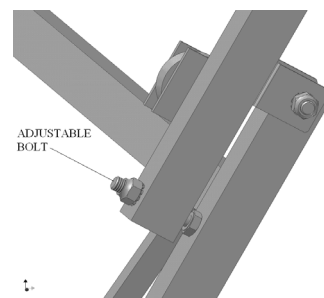

Fig. 6. Connection between the foldable arms

Besides the steel tubes, the basketball goal is also composed of the glass backboard and the basket ring, which also influence its dynamics. Due to the location of these components at the bottom of the structure, accurately modelling their inertial properties was of greater importance

than modelling their stiffness. To represent them, a block with the width and the height of the glass was modelled, while the thickness was selected such that the mass of the block was equal to the sum of the actual masses of the represented objects. For this purpose a linear, 3D solid element was used. The whole structure was rigidly connected to the ceiling.

1.3 Results

For the purposes of correlation and, finally, to identify the correlated mode pairs that are important for the forthcoming analysis, the results of both approaches were analysed.

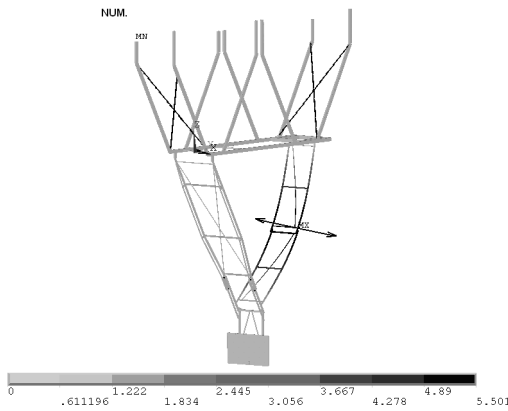

Fig. 7. First mode; numerically assessed deformation, $f_{FEA} = 2.77$ Hz

The first mode shape, Fig. 7, was observed only for the numerical model. This is due to the fact that the accelerometer could not detect this local behaviour occurring away from its position. This local mode is characterized by the bending motion at the folding arms. Due to the simplification in the connection of the arms this numerical solution is only correct up to a certain amplitude of oscillation. As the arms sag under their own weight to the extent of 20 mm, the model correctly represents this oscillation with an amplitude of no more than half of this value. At greater amplitudes, a nonlinear oscillation occurs.

f_{EMA} is the natural frequency assessed in the EMA, while f_{FEA} is the natural frequency resulting from the numerical approach.

In contrast to the first, the second mode was identified with both the experimental and numerical approaches and represents the motion of the goal in the lateral direction, Fig. 8. The

same applies to the global motion of the fourth mode, where a global, torsional motion is well correlated with the numerical approach, Fig 9.

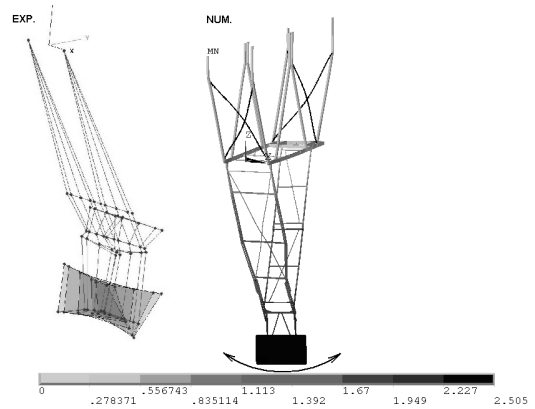

Fig. 8. Second mode; experimentally identified motion (left), $f_{EMA} = 2.71$ Hz, numerically assessed deformation (right), $f_{FEA} = 3.18$ Hz

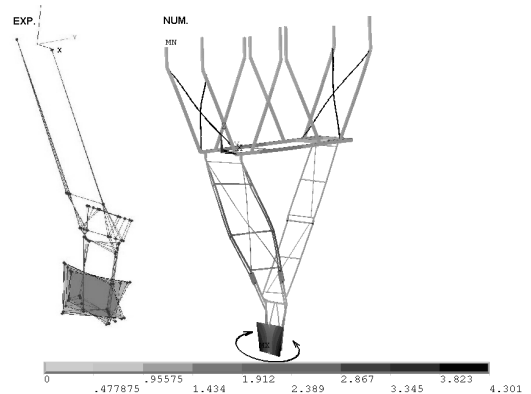

Fig. 9. Fourth mode; experimentally identified motion (left), $f_{EMA} = 6.95$ Hz, numerically assessed deformation (right), $f_{FEA} = 7.20$ Hz

Table 1 compares the numerical and experimental results, where ζ_{EMA} is the damping ratio assessed in the EMA and η is the discrepancy between f_{EMA} and f_{FEA} .

Besides mode 1, modes 3 and 6 were also not identified experimentally. Judging from the numerical results, the reason was again the actual position of the accelerometer and its limited sensitivity, preventing the capture of all the local behaviour of the structure.

Despite this, the correlation between the model and the actual structure was recognized as being valid. Namely, as will be clearly evident in

the next section, our concern was mainly the second numerical mode and its correlation with the experimental one. This mode dominates in the actual, transient response, when the basketball goal is excited laterally, with the initial displacement imitating this mode.

Table 1. Comparison of some of the modal results for the numerical and for the experimental approach

No.	f_{EMA} [Hz]	ζ_{EMA} [/]	f_{FEA} [Hz]	η [%]
1	/	/	2.77	/
2	2.71	0.08	3.18	17
3	/	/	4.96	/
4	6.95	0.048	7.20	4
5	8.24	0.047	8.41	2
6	/	/	8.85	/
7	8.96	0.038	9.02	1
8	10.78	0.041	9.76	9

2 TRANSIENT RESPONSE

With a valid numerical model at our disposal, it was then possible to predict a valid transient response of the goal to different, time-dependent loadings. It was observed that a crucial dynamic behaviour of the structure takes place when there is a lateral loading applied to the structure of the basketball goal. For our analysis, a load case was conceived, where a static load of 900 N (equal to the static lateral load capacity of the goal [12]) is applied to the ring fixture from the side and then the structure is released to oscillate freely. This kind of loading causes a damped, transient response of the structure, gradually returning the structure into its neutral position. Besides the overall stiffness of the structure, which defines the initial displacements, the damping is one of the most important aspects to account for as accurately as possible. Experimentally identified damping, as a direct result of the EMA, is thus an important piece of information that influences the validity of the transient response analysis. Moreover, in order for the identified damping to be easily used in the numerical approach, a proportional (or Rayleigh) damping was adopted [13]. In this model it is assumed that the damping matrix of a multiple-degree-of-freedom system is proportional to the mass and stiffness matrices.

$$[C] = \varepsilon [K] + \nu [M], \quad (2)$$

where ε and ν are constants and the following relations hold

$$2\omega_r \xi_r = \phi_r^T [C] \phi_r. \quad (3)$$

Due to the orthogonality of the eigenvectors with respect to the mass and stiffness matrices, Eq. (3) can be rewritten as

$$2\omega_r \xi_r = \nu + \varepsilon \omega_r^2, \quad (4)$$

or

$$\xi_r = \frac{1}{2\omega_r} \nu + \frac{\omega_r}{2} \varepsilon, \quad r = 1, 2, \dots, N. \quad (5)$$

In Eq. (5) ξ_r is defined as the modal damping ratio for mode r , while N is the number of modes calculated or experimentally identified.

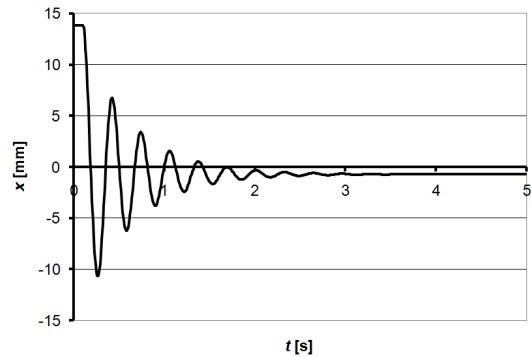

Fig. 10. Response of the structure at the place of the ring fixture, where a lateral force of 900 N was applied

The response of a continuous system, like the structure of the basketball goal being reviewed, is the sum of all of its modes in general. However, in our case it was observed that in the transient response, due to the actual, lateral force and calculated using the FEA, there is a dominant motion of the second mode shape. Due to this characteristic, only the identified damping ratio corresponding to the second mode shape was used to derive the coefficients of the proportional damping model to be used in the FEA analysis. The response of the structure to the load case described above is shown in Fig. 10.

One of the purposes of this research was to compare the dynamic attributes of the goal with the regulations for this type of sports equipment. Because of sufficient damping, the initial oscillation amplitude of 14 mm substantially

drops with every swing, consequently decreasing to a negligible value in a time of about 2.5 s. This is well below the allowed visible vibration duration time of 4 seconds, clearly indicating the suitability of the goal.

3 CONCLUSION

The use of the experimental modal analysis and the finite-element method at the same time proves to be very useful in research on structural dynamics. Experimental results are used to correctly build and, afterwards, validate the numerical model, which can then be used to analyse the various aspects of the behaviour of the structure. In the case of a ceiling basketball goal, the two most common load cases are an impulse from a basketball hitting the backboard or an impulse from a player scoring with a dunk shot. Since both of these impulses are very difficult to assess, a different approach was adopted, using a static force and suddenly eliminating it. With the use of the force, equivalent to the static load capacity of the goal, the maximum static deformation was achieved, ensuring an oscillation of the maximum amplitude was analysed.

The biggest advantage of a numerical model is that it enables us to examine the effect of structural modifications on the behaviour of the structure. Typical modifications are a weight reduction, a material change and thus a manufacturing-costs reduction, or any static or dynamic behaviour improvements to the structure or its components. Having such valid models, the next time this can be used in a prototyping phase, without the necessity to have an existing structure or a prototype.

4 REFERENCES

- [1] FIBA regulations: »Official Basketball Rules 2008, Basketball Equipment, As approved by FIBA Central Board«, Beijing.
- [2] Ren, Y., Lim, T.M., Lim, M.K. (1998). Identification of properties of nonlinear joints using dynamic test data. *Journal of Vibration and Acoustics - Transactions of the Asme*, 120, p. 324-330.
- [3] Oldfield, M., Ouyang, H., Mottershead, J. E. (2003). Bolted joints under dynamic loading. *VIII International Conference on Recent Advances in Structural Dynamics*, Southampton, 14-16 July, ISVR.
- [4] Čelič, D., Boltežar, M. (2008). Identification of the dynamic properties of joints using frequency–response functions. *Journal of Sound and Vibration*, 317, p. 158–174.
- [5] Čelič, D., Boltežar, M. (2009). The influence of the coordinate reduction on the identification of the joint dynamic properties. *Mechanical Systems and Signal Processing*, 23, p. 1260–1271.
- [6] Čermelj, P., Boltežar, M. (2006). Modelling localised nonlinearities using the harmonic nonlinear super model. *Journal of Sound and Vibration*, 298, 1099–1112.
- [7] Fotsch, D. W. (2001). Development of Valid FE Models for Structural Dynamic Design. *PhD Thesis*, Imperial College of Science, Technology and Medicine, University of London.
- [8] Liu, W. (2000). Structural Dynamic Analysis and Testing of Coupled Structures. *PhD Thesis*, Imperial College of Science, Technology and Medicine, University of London.
- [9] Ewins, D.J., Inman, D.J. (2001). Structural Dynamics @ 2000: Current Status and Future Directions. *Research Studies Press Ltd.*, Baldock, Hertfordshire.
- [10] Dascotte, E., Swindell, R. (2003). Beyond modal animations: modal pre-test planning, structural dynamics modifications & integration with FEA. *Modal Analysis and Lab Test Simulation Seminar*, m+p International, Hants.
- [11] Catbas, F.N., Brown, D.L., Aktan, A.E. (2004). Parameter estimation for multiple-input multiple-output modal analysis of large structures. *Journal of Engineering Mechanics-ASCE*, vol. 130, p. 921-930.
- [12] European standard: »prEN 1270 rev 2004, *Playing field equipment - Basketball equipment - Functional and safety requirements, test method*«, Brussels.
- [13] Maia, N.M.M., Silva, J.M.M., He, J., Lieven, N.A.J., Lin, R.M., Skingle, G.W., To, W., Urgueira, A.P.V. (1997). *Theoretical and Experimental Modal Analysis*. Research Studies Press Ltd., Taunton, Somerset.